

# SERIE PRISMA

PRISMA15, PRISMA25, PRISMA35N Y PRISMA45N

BOMBA MULTITAPAS HORIZONTAL

# SERIE PRISMA

PRISMA15, PRISMA25, PRISMA35N Y PRISMA45N

## ESPECIFICACIONES

Bombas centrífugas multietapas horizontales para aplicaciones de bombeo de agua limpia donde se requiera una bomba robusta y compacta. Destaca por su operación extremadamente silenciosa y su capacidad autoaspirante hasta 2 m.

## APLICACIONES

- Suministro de agua a viviendas
- Riego a jardines
- Sistemas hidroneumáticos

## MATERIALES

- Camisa(tubo envolvente) en acero inoxidable 304
- Eje motor en acero inoxidable 420
- Impulsores en acero inoxidable 304
- Difusores fabricados en tecnopolímero Noryl® (PPO con Carga de fibra de vidrio)
- Cuerpo de aspiración e impulsión en hierro fundido
- Sello mecánico de Grafito/alúmina
- Carcasa del motor en aluminio

## MOTOR

- Asíncrono, dos polos
- Protección IP 44
- Aislamiento clase F
- Servicio continuo

## CARACTERÍSTICAS DE OPERACIÓN

- Temperatura del líquido (°C): Min: 4 - Max: 35
- Autoaspirante a 2 m.c.a

## CÓDIGO DE LA BOMBA

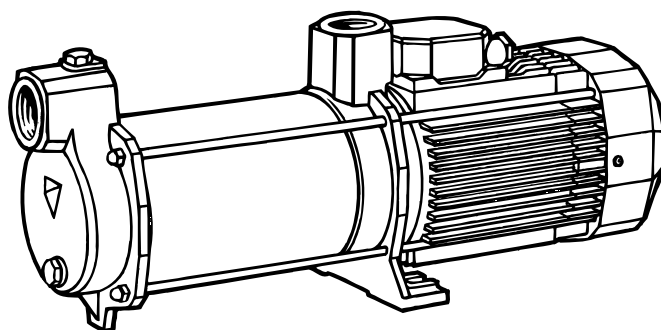
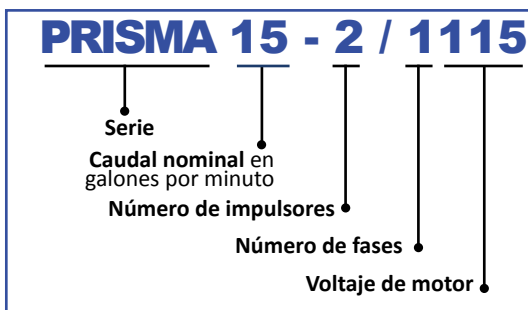

## BOMBAS CENTRÍFUGAS MULTIETAPAS HORIZONTALES MARCA ESPA Serie PRISMA

CÓDIGO	HP	KW	AMP.	FASES X VOLTS	CAPACITOR (µf)	SUCCIÓN Y DESCARGA (PULGADAS)	DIÁMETRO MÍNIMO RECOMENDADO PARA TUBERÍA DE SUCCIÓN (PULGADAS)	PRESIÓN AL CIERRE m / psi	GASTO (LPM)						PESO (Kg)	
									14 m 19.8 psi	20 m 28.4 psi	30 m 42.6 psi	40 m 56.8 psi	50 m 71 psi	60 m 85.2 psi		
PRISMA15-2/1115	1/2	0.37	5.8	1 x 115	12	1" x 1"	1.25"	34 / 48	62	50	23				8.6	
PRISMA15-3/1115	3/4	0.55	8.5	1 x 115	30			50 / 71	70	63	50	32				9.2
PRISMA15-3/1220	3/4	0.55	4.7	1 x 220	16			50 / 71	70	63	50	32				9.2
PRISMA25-2/1115	1	0.75	11.5	1 x 115	30			34 / 48	130	108	55					14
PRISMA25-2/1220	1	0.75	6	1 x 220	16			34 / 48	130	108	55					14
PRISMA25-3/1115	1.5	1.1	16.5	1 x 115	60			50 / 71	No operar en este punto	135	112	82				18.5
PRISMA25-3/1220	1.5	1.1	8.3	1 x 220	25			50 / 71	No operar en este punto	135	112	82				18.5
PRISMA25-4/1220	2	1.5	12	1 x 220	30			66 / 93	No operar en este punto	No operar en este punto	132	117	92	65		21.2
PRISMA25-4/3220	2	1.5	6.5/3.8	3x220/440	--			66 / 93	No operar en este punto	No operar en este punto	132	117	92	65		18.5
PRISMA35N-2/1220	1.5	1.1	9.6	1x220	30			1.25"x1.25"	1.5"	42 / 59	200	170	125	50		
PRISMA35N-2/3224	1.5	1.1	5.2/3	3x220/440	--	42 / 59	200			170	125	50				19.4
PRISMA35N-3/3224	2	1.5	8/4.5	3x220/440	--	64 / 90	No operar en este punto			200	175	144	107	50		22.4
PRISMA35N-4/3224	3	2.2	9/5	3x220/440	--	78 / 110	No operar en este punto			200	180	157	130	100		22.8
PRISMA45N-2/1220	2	1.5	10.5	1 x 220	30	1.5" x 1.25"	2"	38 / 53	270	230	150				22.5	
PRISMA45N-2/3224	2	1.5	8.7/4.7	3x220/440	--			38 / 53	270	230	150					20.1
PRISMA45N-3/3224	3	2.2	8.6/4.7	3x220/440	--			55 / 78	295	273	225	177	100			22.9

Nota: Las bombas PRISMA trifásicas pueden ser conectadas a 220V o 440V según sea necesario, siguiendo el diagrama descrito en la caja de conexiones.



# CURVAS DE RENDIMIENTO

## PRISMA 15

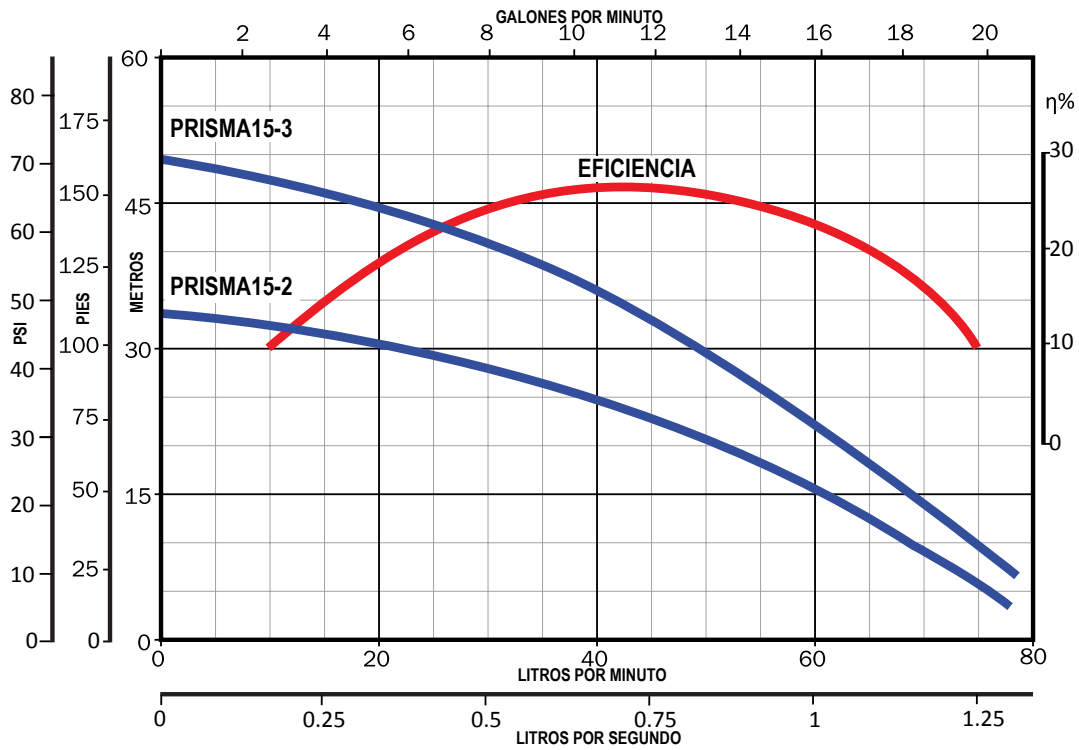

## PRISMA 25

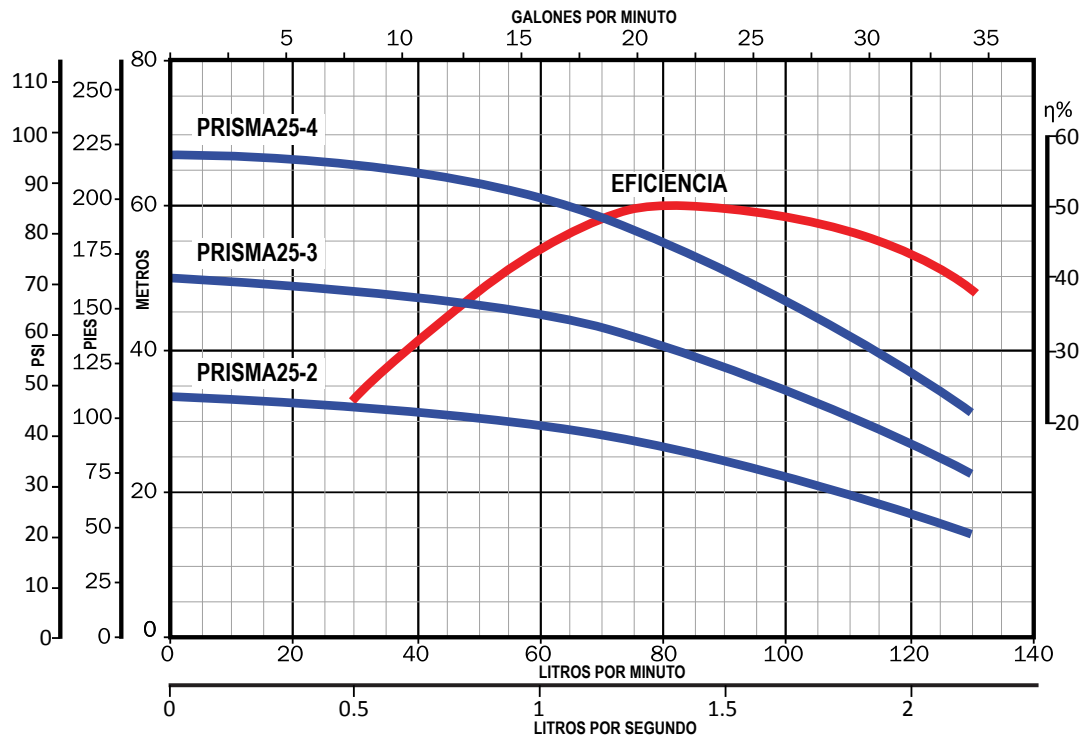

# CURVAS DE RENDIMIENTO

## PRISMA 35N

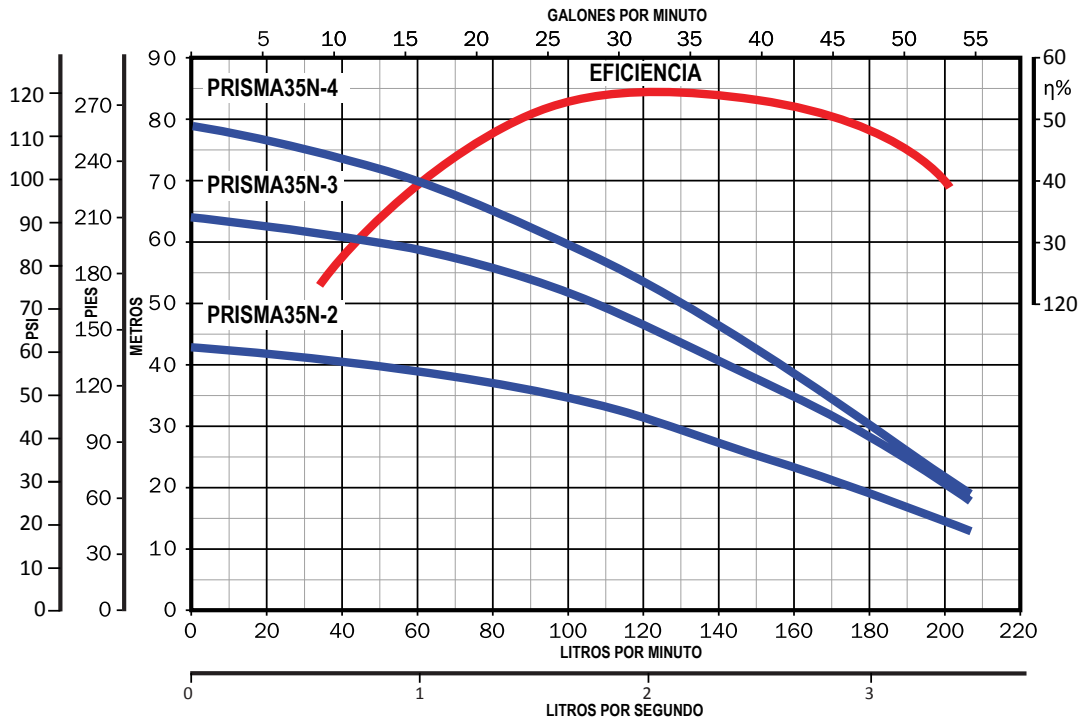

## PRISMA 45N

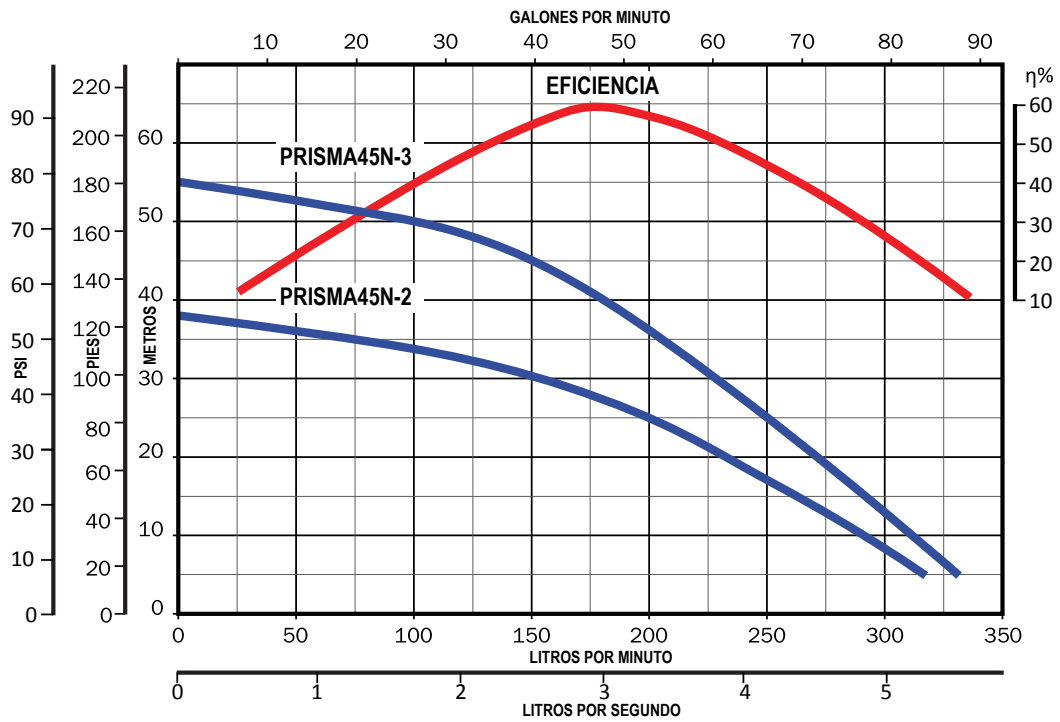



**BOMBA MULTIETAPAS  
HORIZONTAL**

**PRISMA**

## DIMENSIONES

### PRISMA 15

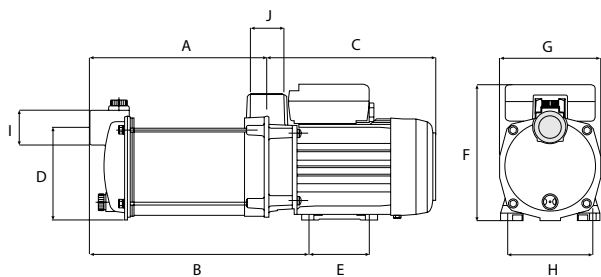

### PRISMA 25

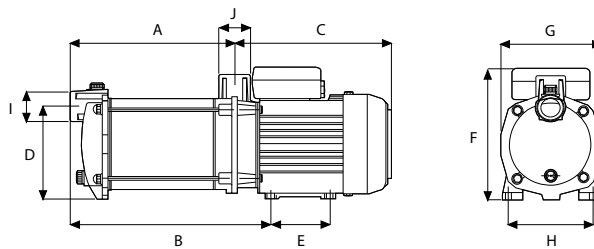

CÓDIGO	A	B	C	D	E	F	G	H	I	J	Kg.
PRISMA15-2/1115	163	213	202	110	74	162	121	102	1"	1"	8.6
PRISMA15-3/1115	187	237	202	110	74	162	121	102	1"	1"	9.2
PRISMA15-3/1220	187	237	202	110	74	162	121	102	1"	1"	10.2
PRISMA25-2/1220	175.5	226	218	127	82	184.5	138	118	1"	1"	14
PRISMA25-2/1115	175.5	226	218	127	82	184.5	138	118	1"	1"	15
PRISMA25-3/1115	202	225	286	142	20	212	154	138	1"	1"	18.5
PRISMA25-3/1220	202	225	286	142	20	212	154	138	1"	1"	19.5
PRISMA25-4/1220	229	252	286	142	20	212	154	138	1"	1"	21.2
PRISMA25-4/3220	229	252	286	142	20	212	154	138	1"	1"	22.2

Dimensiones en mm

### PRISMA 35N

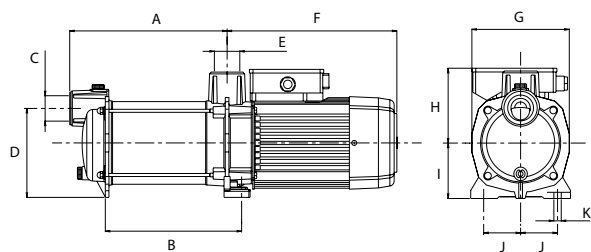

### PRISMA 45N

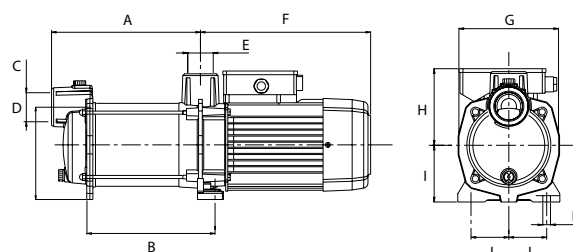

CÓDIGO	A	B	C	D	E	F	G	H	I	J	K	Kg.
PRISMA35N-2/1220	197.6	162.8	1 1/4"	147	1 1/4"	281.5	158	125.3	90	60	12	19.7
PRISMA35N-2/3224	197.6	162.8	1 1/4"	148	1 1/4"	281.5	158	125.3	90	60	12	19.7
PRISMA35N-3/3224	222.1	187.3	1 1/4"	147	1 1/4"	281.5	158	125.3	90	60	12	22.7
PRISMA35N-4/3224	246.6	211.8	1 1/4"	147	1 1/4"	281.5	158	125.3	90	60	12	22.8
PRISMA45N-2/1220	215.2	180.9	1 1/2"	152	1 1/4"	281.5	158	125.3	90	60	12	22.5
PRISMA45N-2/3224	215.2	180.9	1 1/2"	153	1 1/4"	281.5	158	125.3	90	60	12	22.5
PRISMA45N-3/3224	245.9	211.6	1 1/2"	152	1 1/4"	281.5	158	125.3	90	60	12	22.9

Dimensiones en mm

